

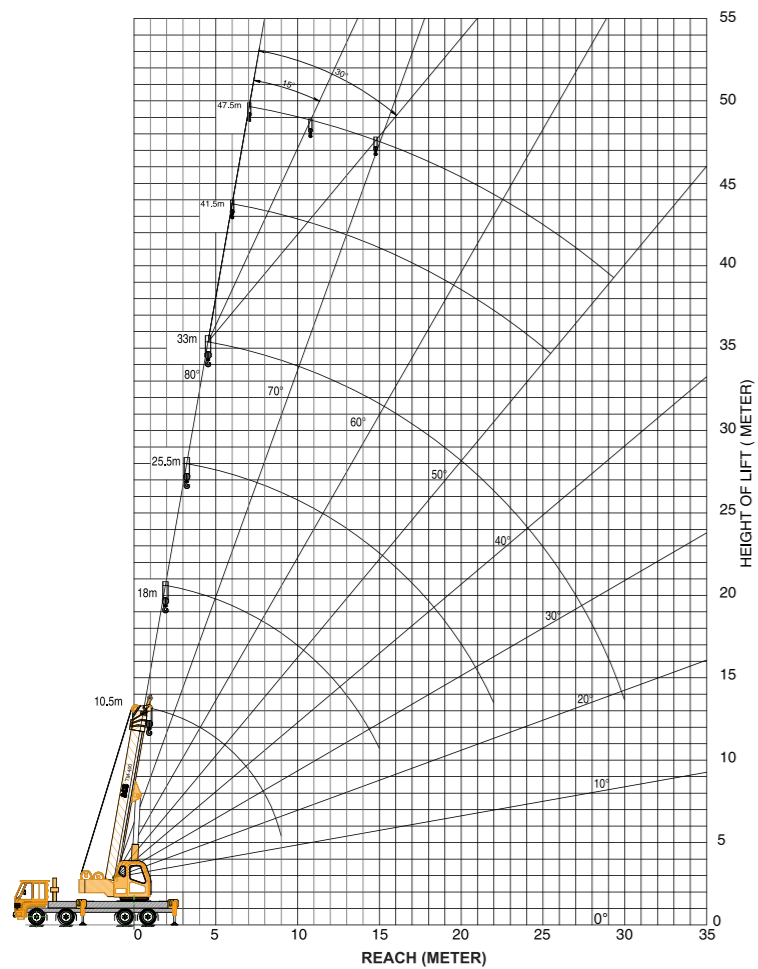

TM 400 40 Tons



Working Range



Dimensions

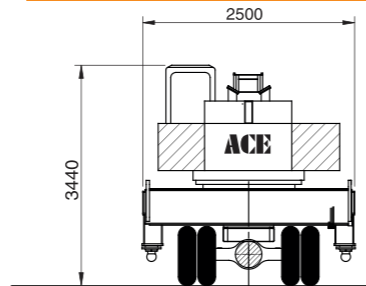

Jib Position	Deduction
X	Meter
1	6.60
2	3.05
3	4.35
4	1.25
5	3.00
6	3.90
7	3.08
8	2.85
9	5.60
10	6.00

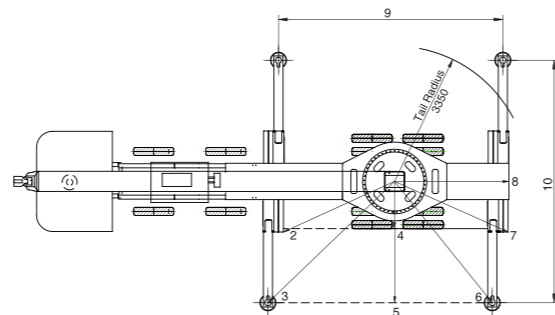

Mobile Cranes (3-50 Tons)



Tractors



Mobile Tower Cranes



Crawler Cranes

Forklifts



Harvester Combine



Vibratory Rollers



Backhoe Loader



Motor Grader



Tower Cranes



Concrete Placing Booms

Nothing beats an ACE

ACE Truck Cranes in action



Specifications

TM400

Crane Chassis	<ul style="list-style-type: none"> Torsion proof chassis is fabricated from high tensile steel plates. Outrigger boxes are integrated with the chassis. Drive is 8x4x4 (4 wheel drive and 4 wheel steer) Full width driver cabin is provided with driver and co-driver seating arrangements. 	Hoist System	Hoist winch is provided with piston type hydraulic motor driving grooved hoist barrel via reduction gear unit. The system is fitted with counter balance valve to control the speed of lowering and to hold the lifted load.
Engine	Ashok Leyland or suitable, turbo charged, inter cooled diesel engine developing 225 bhp@ 2500 rpm	Hook Block	5 sheaves hook block is provided
Clutch	Single plate(381mm), Dry, hydraulic actuated diaphragm type	Hoist Rope	18 mm diameter.
Transmission	Nine speed synchromesh Gear Box with crawler gear.	Capacities	Hydraulic Tank 400 Lts. Fuel Tank 335 Lts.
Top Speed	60 Kmph.	Operator's Cabin (Crane)	Cabin with maximum all round vision is fitted. All controls for crane motion and electrical controls are provided in the cabin. Cabin is fitted with fan and lights.
Brakes	Air pressurized diaphragm operated with dual line arrangement. Flick valves operated pneumatic hand brake on rear and front wheels.	Safety Equipment	<ul style="list-style-type: none"> Safe load indicator provides radius and hook load indication with visual indication of approach to overload and audible indication of overload condition. Overload and Over hoist cut-off. Pressure relief in main circuit. Pilot operated check valves are provided in all the cylinders.
Tyre Size	11.00 X 20-16 ply rating(12+1)	Performance Data	<ul style="list-style-type: none"> Derrick Angle -3° to 80° Derricking time 45-80 secs (In & out) Telescoping time 80-90 secs Slew 0-2 RPM Hoist Single line speed 90 m/min. Outriggers <ul style="list-style-type: none"> Out 34 secs In 26 secs Down 30 secs Up 38 secs
Outrigger	Four hydraulically operated outrigger beams fitted with lock valves. Outrigger blocks are removable and stowable.	Axle loads	Front axle-1 5880 kgs. Front axle-2 5870 kgs. Rear axles 19100 kgs. Total weight 30850 kgs.
Hydraulic System	Triple Gear pump driven by transmission P.T.O, supplies oil to all circuits except steering system.	Optional Equipment	Side folding lattice jib - 8.5 + 6.0 mtrs with three offset positions.
Super Structure	Fabricated with high tensile steel plates and is capable of unlimited slewing in either direction. Super structure is mounted on a sealed, internal teeth slew ring.		
Boom Derricking	Double acting hydraulic cylinder with counter balance safety valve.		
Slewing	Piston type hydraulic motor drives a pinion through reduction gear unit. Double counter balance valve is provided for smooth control and operations.		
Telescopic Boom	Double acting hydraulic cylinder is provided for boom telescoping. Four part boom is fabricated from high tensile steel plates and is extendable from 10.5 m to 33.0 m.		

Rated Lifting Capacity (in Kgs.) 85% Rating

TM400

Radius	360° BLOCKED			
	Jib Closed 10.5 M	Jib Extended 10.5-18.0M	Jib Extended 18.0 - 25.5 M	Jib Extended 25.5 - 33.0 M
Meter	Kgs.	Kgs.	Kgs.	Kgs.
3.0	40000			
3.5	35000	22000		
4.0	28400	21000		
4.5	25500	20000	13000	
5.0	22000	20200	12000	
5.5	19000	17000	11500	8000
6.0	17500	15000	11000	8000
6.5	16000	12000	10000	7000
7.0	14500	11000	9500	6000
8.0	11000	10000	9000	6000
9.0	9000	9000	8000	5500
10.0		7000	7000	5000
12.0		5000	5000	4500
15.0		3000	3000	3000
18.0			2000	2000
22.0			1600	1600
26.0				1000
30.0				800

1. The above capacities are in accordance with Indian Standard Code - IS:4573

2. Rated loads are 85% of tipping loads. The loads shown are gross loads and the weight of the hook block, lifting tackle etc. must be considered as part of the lifted load.

Overall Dimensions

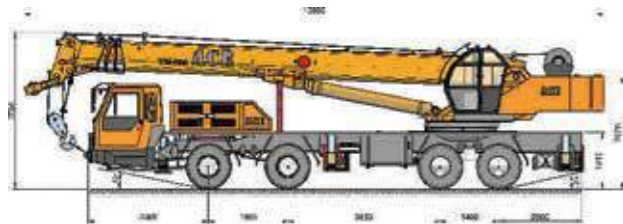

Capacity with Fly Jib (Kgs.)

Elevation of Main Boom	Main Boom + Jib					
	Installation of jib 33m+8.5			Installation of jib 33m+14.5		
	0°	15°	30°	0°	15°	30°
80°	4000	2700	2500	2000	1400	1000
78°	3700	2600	2400	1900	1300	950
75°	3500	2400	2200	1800	1100	900
72°	3300	2100	2000	1750	1000	800
70°	3100	2000	1900	1600	950	750
65°	2500	1950	1850	1350	900	700
60°	1600	1500	1400	1150	800	650
55°	1200	1100	1100	900	700	600
50°	950	800	750	500	500	500

ALL DIMENSIONS ARE IN mm

Rated Lifting Capacity (in Kgs.) 85% Rating

TM250 C - 25 TONS

Radius	360° BLOCKED			
	Jib Closed 10.2 M	Jib Extended 10.2-14.2 M	Jib Extended 14.20 - 18.2 M	Jib Extended 18.2- 22.2 M
Meter	Kgs.	Kgs.	Kgs.	Kgs.
2.75	25000			
3.0	22000	14500		
3.5	19000	13500		
4.0	17000	13000	8500	
4.5	15000	12400	8500	
5.0	14000	12000	8500	6000
5.5	13000	11800	8500	5800
6.0	12700	10500	8000	5200
6.5	10000	10000	7800	4900
7.0		9000	7500	4700
7.5		8500	7200	4400
8.0		7000	6500	4200
9.0		6500	6000	3900
10.0		5000	4800	3700
11.0		4200	3800	3500
12.0		3600	3200	2900
14.0			2600	2400
16.0				1900
18.0				1900

1. The above capacities are in accordance with Indian Standard Code - IS:4573-1982

2. Rated loads are 85% of tipping loads. The loads shown are gross loads and the weight of the hook block, lifting tackle etc. must be considered as part of the lifted load.

3. These capacities are on firm and level surface.

Overall Dimensions

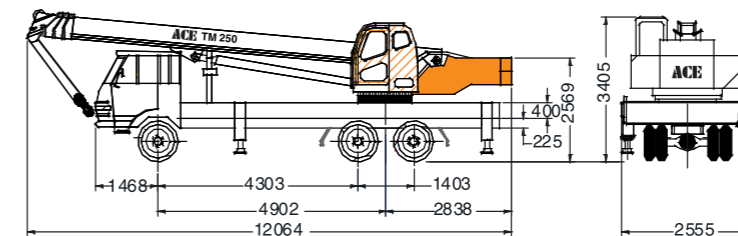

ALL DIMENSIONS ARE IN mm



Specifications

TM250 C - 25 TONS

Truck Chassis	The crane is mounted on modified & adequately reinforced truck chassis	Hoist System	Winch is provided with hook block. Piston type hydraulic motor driving grooved hoist barrel via reduction gear unit. The system is fitted with Counter balance valve to control the speed of lowering.
Engine	Ashok Leyland, water cooled diesel engine developing 165 bhp @ 2400rpm	Hook Block	4 sheaves block is provided
Clutch	Dry, Single Plate (380mm), hydraulically actuated diaphragm type.	Hoist Rope	16 mm Diameter
Transmission	Six Speed Synchromesh Gear box.	Capacities	
Top Speed	60 Kmph.	Hydraulic Tank	400 ltrs.
Brakes	Air pressurized, diaphragm operated with dual Line arrangement. Flick Valves operated pneumatic hand brake on rear wheels only.	Fuel Tank	335 ltrs.
Tyres Size	10.00 X 20-16 PLY Rating (10+1)	Operator's Cabin (Crane)	Cabin with maximum all round vision is fitted with lockable door. All controls for crane motions & electrical controls are provided in the cabin. Cabin light & fan is also fitted.
Out riggers	Four hydraulically operated outrigger beams with vertical hydraulic jacks fitted with lock valves. Outrigger blocks are removable & stowable.	Safety Equipment	<ul style="list-style-type: none"> Safe load indicator which provides radius & hook indication with visual indication of approach to overload & audible indication of overload condition. Over load and over hoist cut off. Pressure relief in main circuit. Pilot operated check valve provided in all the cylinders.
Hydraulic System	Gear type hydraulic pump driven by Transmission PTO,	Performance Data	<ul style="list-style-type: none"> Derrick Angle -2° to 80° Derricking time 50-60 secs Telescoping time 80-90 secs Slew 0-2 RPM Hoist Single line speed 90m/min.
Super Structure	Fabricated with high tensile steel plates and is capable of unlimited slewing in either direction. Super structure is mounted on a sealed, external teeth slewing ring.	<ul style="list-style-type: none"> Outriggers 	<ul style="list-style-type: none"> Out 12 secs In 10 secs Down 17 secs UP 12 secs
Boom Derricking	Double acting hydraulic cylinder with counter balance safety valve.	Axle Loads	<ul style="list-style-type: none"> Front Axle 5750 kgs. Rear Axle 18300 kgs. Total weight 24050 kgs.
Slewing	Piston type hydraulic motor drives a pinion through reduction gear unit. Double counter balance valve is provided for smooth control and operations.	Optional Equipment	Side folding lattice Jib - 8 mtrs.
Telescopic Boom	Double acting hydraulic cylinder is provided for boom telescoping. Three part boom is fabricated from high tensile steel and is extendable from 10.2 to 22.2 mtrs.		



Working Range

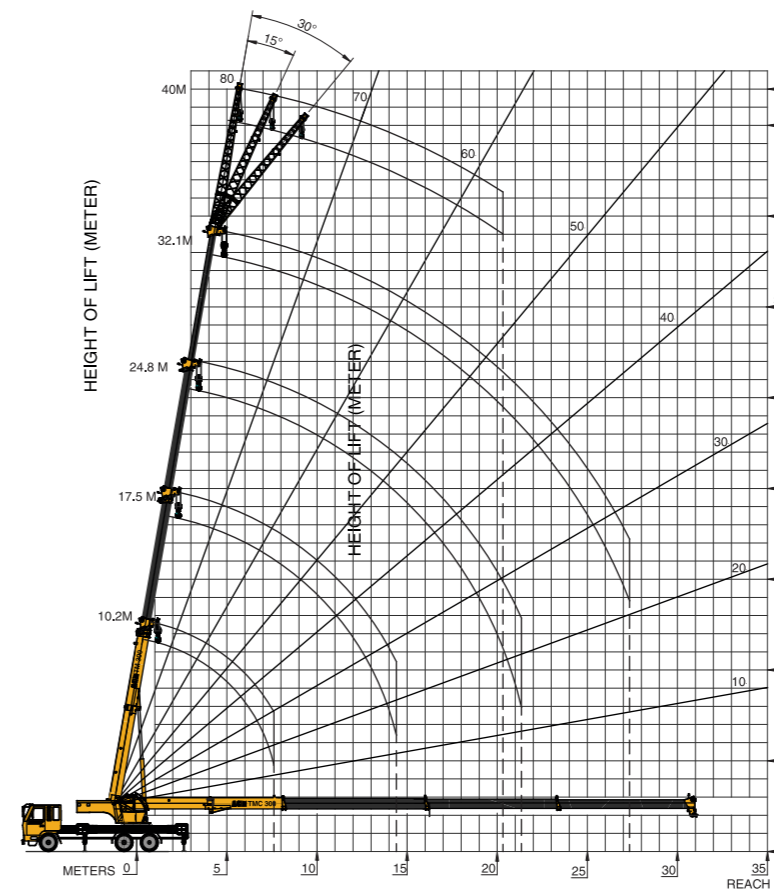

Dimensions

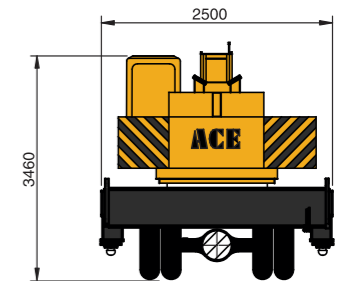

Jib Position	Deduction
X	Meter
1	6.34
2	3.46
3	4.22
4	1.27
5	2.98
6	3.95
7	2.95
8	2.65
9	5.50
10	6.00

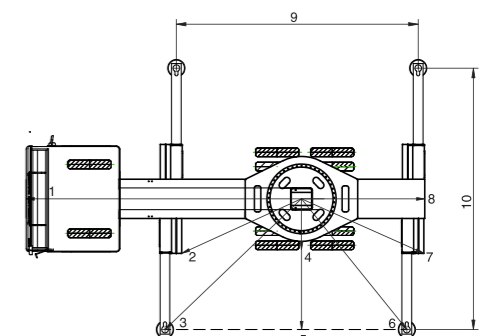

Specifications

TM300 - 30 Tons

Truck Chassis	The crane alongwith auxillary chassis is mounted on suitable truck chassis	Hoist System	Hoist winch is provided with piston type hydraulic motor driving grooved hoist barrel via reduction gear unit. The system is fitted with counter balance valve to control the speed of lowering and to hold the lifted load.
Engine	Water cooled diesel engine	Hook Block	4 sheaves hook block is provided
Clutch	Dry, Single plate(380mm), hydraulically actuated diaphragm type	Hoist Rope	16 mm Diameter.
Transmission	Six speed synchromesh Gear Box	Capacities	
Top Speed	60 Kmph.	Hydraulic Tank	400 lts.
Brakes	Air pressurized diaphragm operated with dual line arrangement. Flick valves operated pneumatic hand brake on rear wheels only.	Fuel Tank	350 lts.
Tyres Size	10.00 X 20-16 PLY Rating(10+1)	Operator's Cabin (Crane)	Cabin with maximum all round vision is fitted. All controls for crane motion and electrical controls are provided in the cabin. Cabin is fitted with fan and lights.
Out riggers	Four hydraulically operated outrigger beams with vertical hydraulic jacks fitted with lock valves. Outriggers blocks are removable & stowable.	Safety Equipment	<ul style="list-style-type: none"> • Safe load indicator provides radius and hook load indication with visual indication of approach to overload and audible indication of over load condition. • Overload and Over hoist cut-off. • Pressure relief in main circuit. • Pilot operated check valves are provided in all the cylinders.
Hydraulic System	Gear type hydraulic pump driven by transmission P.T.O, supplies oil to all circuits except steering system.	Performance Data	<ul style="list-style-type: none"> • Derrick Angle -3° to 80° • Derricking time 70 second (In and out) • Telescoping time 115 second • Slew 0-2.4 RPM. • Hoist Single line speed 90m/min.
Super Structure	Fabricated with high tensile steel plates and is capable of unlimited slewing in either direction. Super structure is mounted on a sealed, internal teeth slew ring.	• Outriggers	
Boom Derricking	Double acting hydraulic cylinder with counter balance safety valve.	Out 34 seconds	
Slewing	Piston type hydraulic motor drives a pinion through reduction gear unit. Double counter balance valve is provided for smooth control and operations.	In 26 seconds	
Telescopic Boom	Double acting hydraulic cylinder is provided for boom telescoping. Four part boom is fabricated from high tensile steel plates and is extendable from 10.2 m to 32.1 m.	Down 30 seconds	
		Up 38 seconds	
		Axle Loads	
		Front Axle 6000 kgs.	
		Rear Axle 19000 kgs.	
		Total weight 25000 kgs.	
		Optional Equipment	Side folding lattice jib - 7.9 mtrs



Working Range

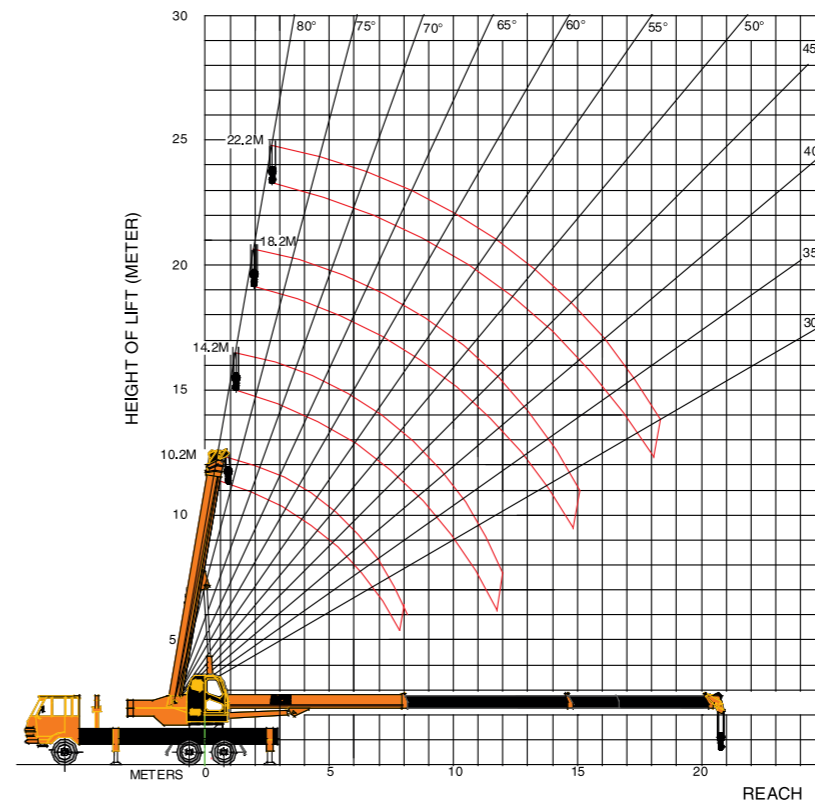

Dimensions

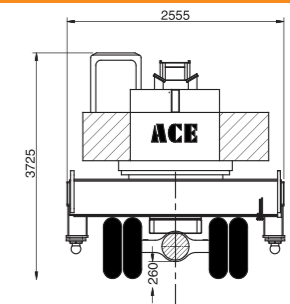

Jib Position	Deduction
X	Meter
1	6.60
2	3.90
3	4.96
4	1.25
5	3.00
6	3.90
7	2.98
8	2.70
9	6.40
10	6.00

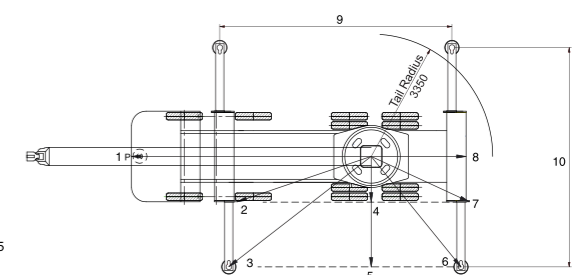

Rated Lifting Capacity (in Kgs.)

TM 250

Radius	360° BLOCKED					
	Jib Closed 10.0 M	Jib Extended 10.0-14.2M	Jib Extended 14.2-18.4M	Jib Extended 18.4-22.6M	Jib Extended 22.6-26.8M	Jib Extended 26.8-31.0M
Meter	Kgs.	Kgs.	Kgs.	Kgs.	Kgs.	Kgs.
2.75	25000					
3.0	23000	15000	13500			
3.5	22000	15000	13500			
4.0	20000	15000	13500	10500		
4.5	17000	14000	13000	10500		
5.0	16000	14000	13000	10000	8000	
5.5	14000	13000	12500	10000	8000	
6.0	12200	12000	12000	9500	7500	6000
6.5	11000	11200	11000	9000	7500	6000
7.0	9000	10000	10000	8000	7200	6000
8.0	7400	8000	8200	7500	6900	5600
9.0		6500	6200	6500	6200	5200
10.0		5100	5200	5300	5000	4700
11.0		4200	4200	4200	4200	4200
12.0		3500	3500	3300	3300	3300
14.0		2500	2500	2500	2400	2200
16.0				1900	1800	1800
18.0				1360	1360	1250
20.0					1000	1000
22.0						650

Rated Lifting Capacity (in Kgs.) 85% Rating

TM300 - 30 Tons

Radius	360° BLOCKED			
	Jib Closed 10.2 M	Jib Extended 10.2-17.5 M	Jib Extended 17.5 - 24.8 M	Jib Extended 24.8- 32.1M
Meter	Kgs.	Kgs.	Kgs.	Kgs.
2.75	30000			
3.0	28000			
3.5	26500			
4.0	24200	13500		
4.5	21500	12500		
5.0	19500	12000		
5.5	17500	11000	8800	
6.0	15500	10500	8100	
6.5	13500	10000	7500	
7.0	12000	9000	7000	6300
8.0	10000	8000	6500	6000
9.0		7000	5500	5500
10.0		6000	5000	5000
12.0		4500	4000	3500
14.0		3500	3200	3100
16.0		2500	2500	2400
18.0			2000	2000
20.0			1500	1500
22.0			1200	1200
24.0				1000
26.0				800
28.0				600
30.0				400

1. The above capacities are in accordance with Indian Standard Code - IS:4573

2. Rated loads are 85% of tipping loads. The loads shown are gross loads and the weight of the hook block, lifting tackle etc. must be considered as part of the lifted load.

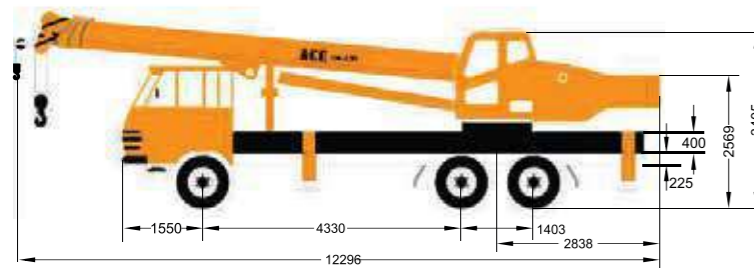

Boom Elevation	FOR 31m + 8m	
80°	3000	3000
78°	2800	2800
76°	2700	2700
74°	2600	2600
72°	2500	2500
70°	2350	2300
68°	2200	1900
66°	2000	1550
64°	1900	1250
62°	1800	950
60°	1650	750
58°	1500	550
56°	1200	400
54°	1000	
52°	800	
50°	600	
45°	400	

Elevation of Boom	Main Boom + Jib 32.1m+7.9m		
	Installation angle of jib		
	0°	15°	30°
80°	3000	2000	900
78°	2500	1800	850
75°	1800	1600	800
72°	1500	1300	750
70°	1250	1100	700
65°	1000	800	600
60°	800	600	
55°	700		

Overall Dimensions

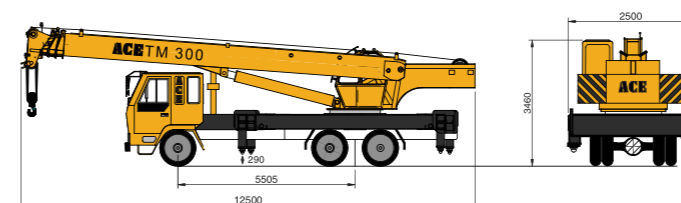

ALL DIMENSIONS ARE IN mm



TM 250

25 Tons



Lifting dimensions

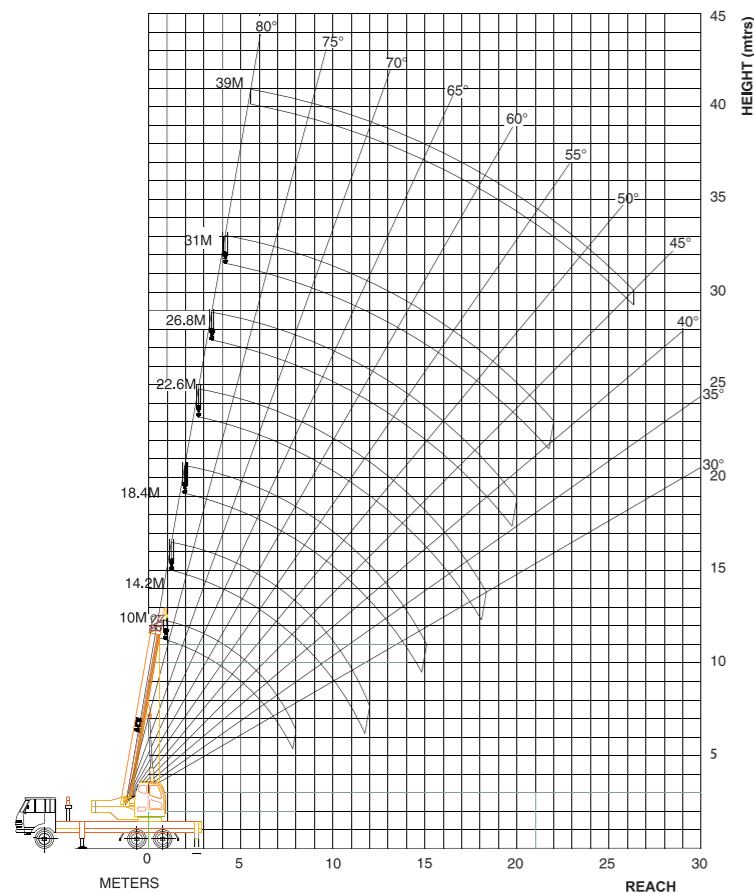

Dimensions

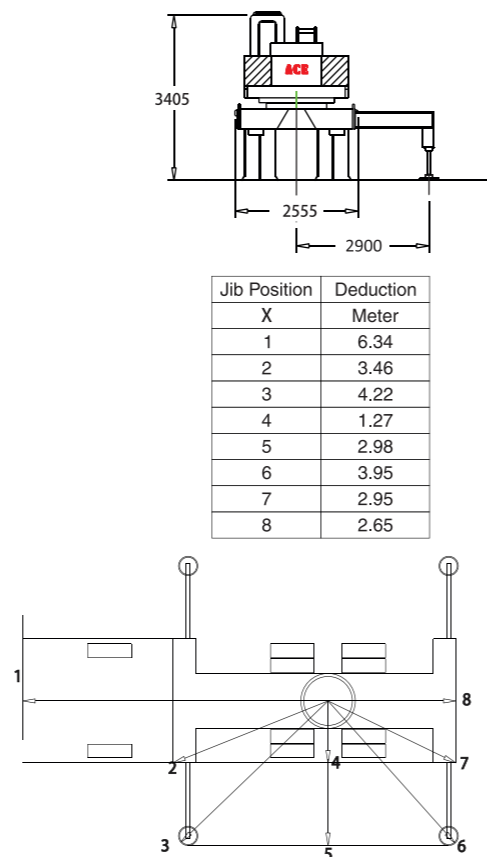

Specifications

TM 250

Truck Chassis	The crane is mounted on modified & adequately reinforced truck chassis	Hoist System	Hoist winch is provided with piston type hydraulic motor driving grooved hoist barrel via reduction gear unit. The system is fitted with counter balance valve to control the speed of lowering
Engine	Water cooled diesel engine	Hook Block	4 sheaves block is provided
Clutch	Dry, Single Plate (380mm), hydraulically actuated diaphragm type.	Hoist Rope	16 mm Diameter
Transmission	Six Speed Synchronmesh Gear box.	Capacities	
Top Speed	60 Kmph.	Hydraulic Tank	400 Itrs.
Brakes	Air pressurized, diaphragm operated with dual Line arrangement. Flick Valves operated pneumatic hand brake on rear wheels only.	Fuel Tank	335 Itrs.
Tyres Size	10.00 X 20-16 PLY Rating (10+1)	Operator's Cabin (Crane)	Cabin with maximum all round vision is fitted with lockable door. All controls for crane motions & electrical controls are provided in the cabin. Cabin light & fan is also fitted.
Out riggers	Four hydraulically operated outrigger beams with vertical hydraulic jacks fitted with lock valves. Outrigger blocks are removable & stowable.	Safety Equipment	<ul style="list-style-type: none"> Safe load indicator which provides radius & hook indication with visual indication of approach to overload & audible indication of overload condition. Over load and over hoist cut off. Pressure relief in main circuit. Pilot operated check valve provided in all the cylinders.
Hydraulic System	Gear type hydraulic pump driven by Transmission PTO,	Performance Data	
Super Structure	Fabricated with high tensile steel plates and is capable of unlimited slewing in either direction. Super structure is mounted on a sealed, internal teeth slewing ring.	<ul style="list-style-type: none"> Derrick Angle: -2° to 80° Derricking time: 50-60 secs Telescoping time: 80-90 secs Slew: 0-2 RPM Hoist Main: Single line speed 90 m/min. 	
Boom Derricking	Double acting hydraulic cylinder with counter balance safety valve.	<ul style="list-style-type: none"> Outriggers Out: 12 secs In: 10 secs Down: 17 secs UP: 12 secs 	
Slewing	Piston type hydraulic motor drives a pinion through reduction gear unit. Double counter balance valve is provided for smooth control and operations.	Axle Loads	
Telescopic Boom	Double acting hydraulic cylinder is provided for boom telescoping. Four part boom is fabricated from high tensile steel and is extendable from 10 mtrs to 31 mtrs.	Front Axle	5950 kgs
		Rear Axle	18950 kgs
		Total weight	24900 kgs
		Optional Equipment	Side folding lattice Jib - 8 mtrs.